

Data Sheet



Article number: 20490288BSW

Description: E+G Clamp mounting - GN 490-28-8-B-SW

Measures

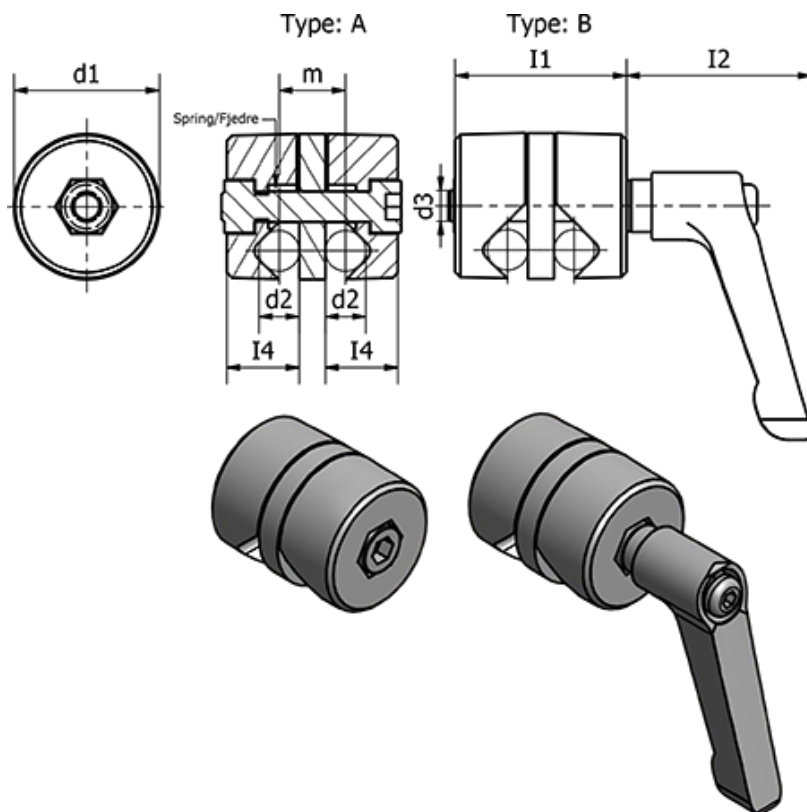

d1 = 28	m = 13
d2 = 8	Weight (g) = 80
d3 = M6	
I1 = 33	
I2 = 35	
I3 = 45	
I4 = 14	
I5 = 5	